

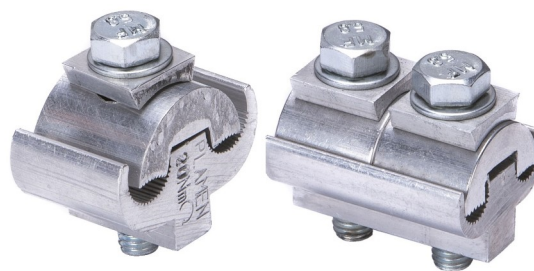

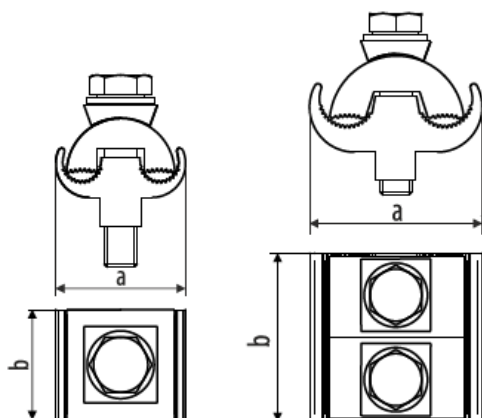







KODNI BROJ: S41292x
Naziv proizvoda: Unimax stezaljka AL - KALAJISAN

TEHNIČKA SPECIFIKACIJA PROIZVODA

Opis: Unimax stezaljka AL - KALAJISAN namenjena je za povezivanje dva neizolovana aluminijumska ili bakarna provodnika.



| Br. | Presek provodnika (mm ²) | Kodni broj | Tip | Dimenzije (mm) | | Izolovano kućište | Pakovanje | | | | Barkod |
|-----|--------------------------------------|------------|-------------|----------------|------|-------------------|--------------------|--------------------------|----------------------------|---------------------------|--------------------------------------------------------------------------------------------------------|
| | | | | a | b | | Težina proizv. (g) | Broj komada u kesi (kom) | Broj komada u kutiji (kom) | Ukupna težina kutije (kg) | |
| 1 | 16-50 | S41-29-21 | Al 16-50/1 | 31 | 26 | IZO-14 | 47,80 | 100 | 300 | 14,83 |  8605031039771 |
| 2 | 16-50 | S41-29-28 | Al 16-50/2 | 31 | 40 | IZO-15 | 94,50 | 50 | 150 | 14,67 |  8605031039788 |
| 3 | 6-95 | S41-29-24 | Al 6-95/1 | 41 | 26 | IZO-15 | 66,30 | 50 | 200 | 13,75 |  8605031039795 |
| 4 | 6-95 | S41-29-29 | Al 6-95/2 | 41 | 40 | IZO-15 | 99,40 | 50 | 150 | 15,40 |  8605031039801 |
| 5 | 16-120 | S41-29-22 | Al 16-120/2 | 42,9 | 42 | IZO-15 | 117,70 | 50 | 150 | 18,15 |  8605031039818 |
| 6 | 16-120 | S41-29-25 | Al 16-120/3 | 42,9 | 62,5 | IZO-16 | 181,70 | - | 50 | 9,58 |  8605031039825 |
| 7 | 16-150 | S41-29-30 | Al 16-150/2 | 42,9 | 42 | IZO-16 | 114,10 | - | 150 | 17,61 |  8605031037326 |
| 8 | 50-240 | S41-29-23 | Al 50-240/2 | 60 | 43 | IZO-16 | 246,20 | 10 | 50 | 12,80 |  8605031039832 |
| 9 | 50-240 | S41-29-27 | Al 50-240/2 | 60 | 72 | - | 317,70 | - | 50 | 16,38 |  8605031039849 |

Ostale karakteristike

Materijal tela: Legura Aluminijuma-KALAJISANA
Vijak / Podloška: Galvanski cinkovan čelik
Zahtevani alat: Ključ odgovarajuće veličine
Oznake: Oznaka proizvođača, presek provodnika, moment pritezanja vijka

