

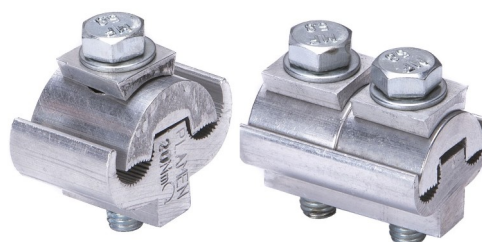

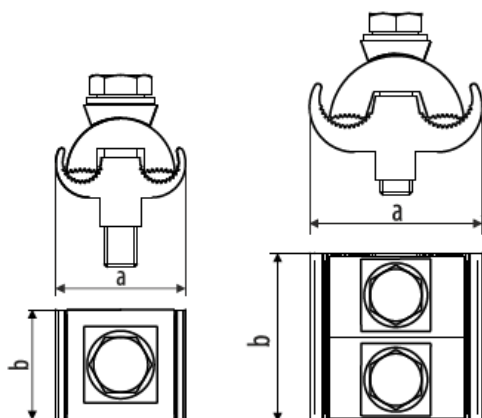







CODE: S41292x
Item: Unimax aluminum PG connector – TIN-COATED

PRODUCT TECHNICAL SPECIFICATION

Description: Unimax aluminum PG connector – TIN-COATED is designed for connection of non-insulated aluminum or copper conductors.



No.	Cable cross-section (mm ²)	Code	Type	Dimensions (mm)		Bolt	Insulating case	Packing				Barcode
				a	b			Product weight (g)	Bag packing (pcs)	Box packing (pcs)	Box BRUTO weight (kg)	
1	Al 16-50 / Cu 16-35	S41-29-21	Al 16-50 / Cu 16-35/1	31	26	M8x35	IZO-14	47,80	100	300	14,83	 8605031039771
2	Al 16-50 / Cu 16-35	S41-29-28	Al 16-50 / Cu 16-35/2	31	40	M8x35	IZO-15	94,50	50	150	14,67	 8605031039788
3	Al 6-95 / Cu 6-70	S41-29-24	Al 6-95 / Cu 6-70/1	41	26	M8x40	IZO-15	66,30	50	200	13,75	 8605031039795
4	Al 6-95 / Cu 6-70	S41-29-29	Al 6-95 / Cu 6-70/2	41	40	M8x40	IZO-15	99,40	50	150	15,40	 8605031039801
5	Al 16-120 / Cu 16-95	S41-29-22	Al 16-120 / Cu 16-95/2	42,9	42	M8x40	IZO-15	117,70	50	150	18,15	 8605031039818
6	Al 16-120 / Cu 16-95	S41-29-25	Al 16-120 / Cu 16-95/3	42,9	62,5	M8x40	IZO-16	181,70	-	50	9,58	 8605031039825
7	Al 16-150 / Cu 16-120	S41-29-30	Al 16-150 / Cu 16-120/2	42,9	42	M8x40	IZO-16	114,10	-	150	17,61	 8605031037326
8	Al 50-240 / Cu 50-185	S41-29-23	Al 50-240 / Cu 50-185/2	60	43	M10x60	IZO-16	246,20	10	50	12,80	 8605031039832
9	Al 50-240 / Cu 50-185	S41-29-27	Al 50-240 / Cu 50-185/3	60	72	M10x60	-	317,70	-	50	16,38	 8605031039849

Other characteristics

Body material: Aluminum alloy-TIN-COATED
Bolt / Washer: Galvanized steel (other per client request)
Required tools: Wrench of appropriate size
Marking: Manufacturer, cable cross-section, screw tightening torque

