

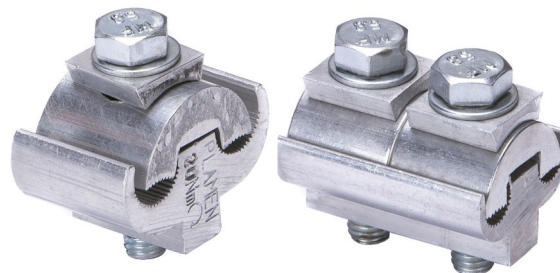

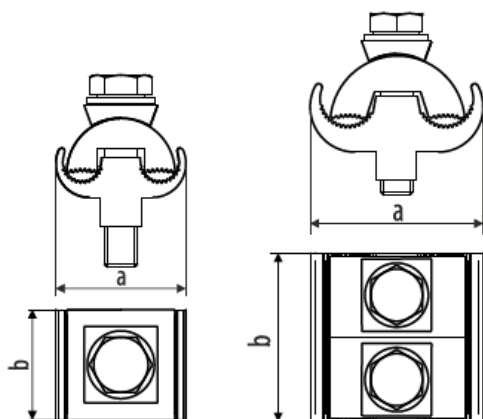







**CODE:** P41292x  
**Item:** Unimax aluminum PG connector

## PRODUCT TECHNICAL SPECIFICATION

**Description:** Unimax aluminum PG connector is designed for connection of two non-insulated Al conductors.



No.	Cable cross-section (mm <sup>2</sup> )	Code	Type	Dimensions (mm)		Insulating case	Packing			Barcode	
				a	b		Product weight (g)	Bag packing (pcs)	Box packing (pcs)		Box BRUTO weight (kg)
1	16-50	P41-29-21	Al 16-50/1	31	26	IZO-14	47,80	100	300	14,83	 8605031010695
2	16-50	P41-29-28	Al 16-50/2	31	40	IZO-15	94,50	50	150	14,67	 8605031039665
3	6-95	P41-29-24	Al 6-95/1	41	26	IZO-15	66,30	50	200	13,75	 8605031035261
4	6-95	P41-29-29	Al 6-95/2	41	40	IZO-15	99,40	50	150	15,40	 8605031039672
5	16-120	P41-29-22	Al 16-120/2	42,9	42	IZO-15	117,70	50	150	18,15	 8605031010701
6	16-120	P41-29-25	Al 16-120/3	42,9	62,5	IZO-16	181,70	-	50	9,58	 8605031033861
7	16-150	P41-29-30	Al 16-150/2	42,9	42	IZO-16	114,10	-	150	17,61	 8605031037319
8	50-240	P41-29-23	Al 50-240/2	60	43	IZO-16	246,20	10	50	12,80	 8605031010718
9	50-240	P41-29-27	Al 50-240/3	60	72	-	317,70	-	50	16,38	 8605031039689

### Other characteristics

**Body material:** Aluminum alloy  
**Bolt / Washer:** Galvanized steel (other per client request)  
**Required tools:** Wrench of appropriate size  
**Marking:** Manufacturer, cable cross-section, screw tightening torque

