

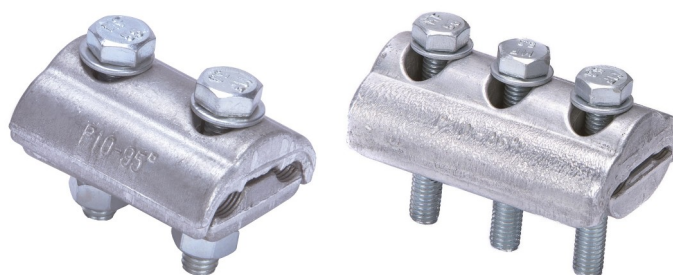

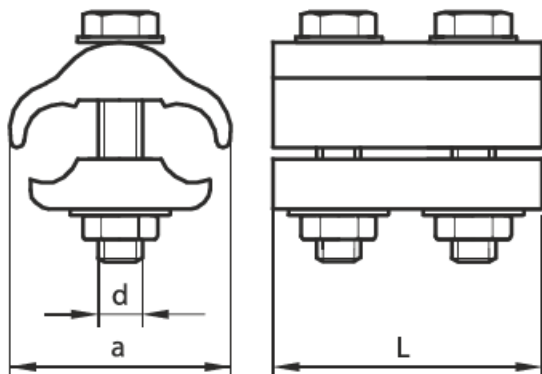



CODE: D41290x
Item: Unimax aluminum PG connector - D

PRODUCT TECHNICAL SPECIFICATION

Description: Unimax aluminum PG connector – D is designed for connection of two non-insulated Al conductors.



| No. | Cable cross-section (mm ²) | Code | Type | Dimensions (mm) | | | Packing | | | | Barcode |
|-----|--|-----------|---------------|-----------------|----|----|--------------------|-------------------|-------------------|-----------------------|--|
| | | | | d | a | L | Product weight (g) | Bag packing (pcs) | Box packing (pcs) | Box BRUTO weight (kg) | |
| 1 | 4-25 | D41-29-02 | Al 4-25 / 2 | M6 | 24 | 40 | 45,00 | 50 | 300 | 14,00 |  8605031003772 |
| 2 | 6-35 | D41-29-03 | Al 6-35 / 2 | M6 | 28 | 41 | 50,00 | 50 | 300 | 15,49 |  8605031003789 |
| 3 | 6-50 | D41-29-04 | Al 6-50 / 2 | M8 | 35 | 45 | 97,00 | 50 | 250 | 24,74 |  8605031003796 |
| 4 | 10-95 | D41-29-05 | Al 10-95 / 2 | M8 | 40 | 53 | 127,80 | 25 | 150 | 19,66 |  8605031003802 |
| 5 | 10-95 | D41-29-26 | Al 10-95 / 3 | M10 | 44 | 73 | 200,00 | 25 | 100 | 20,49 |  8605031035469 |
| 6 | 25-150 | D41-29-06 | Al 25-150 / 2 | M10 | 50 | 64 | 229,20 | 25 | 100 | 23,41 |  8605031003819 |

Other characteristics

Body material: Aluminum alloy
Bolt / Washer: Galvanized steel (other per client request)
Required tools: Wrench of appropriate size
Marking: P, cable cross-section
Standard: DIN 48072/1

