

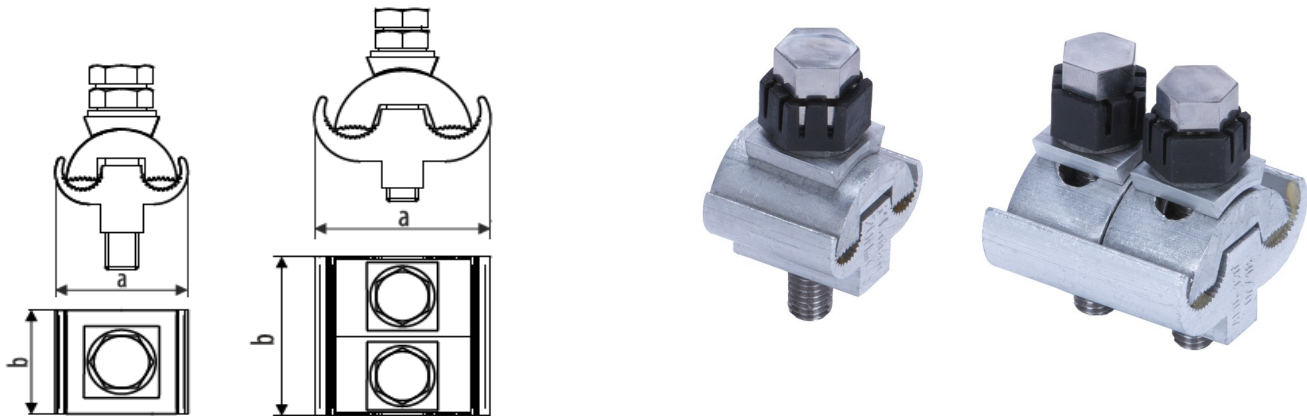







CODE: S41294x
Item: Unimax aluminum PG connector – TIN-COATED - SHEAR-HEAD

PRODUCT TECHNICAL SPECIFICATION

Opis: Unimax aluminum PG connector – TIN-COATED - SHEAR-HEAD is designed for connection of non-insulated aluminum or copper conductors.



No.	Cable cross-section (mm ²)	Code	Type	Dimensions (mm)		Insulating case	Packing			Barcode	
				a	b		Product weight (g)	Bag packing (pcs)	Box packing (pcs)		Box BRUTO weight (kg)
1	16-50	S41-29-41	Al 16-50/1	31	26	IZO-14	47,80	100	300	14,83	 8605031039856
2	16-50	S41-29-48	Al 16-50/2	31	40	IZO-15	94,50	50	150	14,67	 8605031039863
3	6-95	S41-29-44	Al 6-95/1	41	26	IZO-15	66,30	50	200	13,75	 8605031039870
4	6-95	S41-29-49	Al 6-95/2	41	40	IZO-15	99,40	50	150	15,40	 8605031039887
5	16-120	S41-29-42	Al 16-120/2	42,9	42	IZO-15	117,70	50	150	18,15	 8605031039894
6	16-120	S41-29-45	Al 16-120/3	42,9	62,5	IZO-16	181,70	-	50	9,58	 8605031039900
7	50-240	S41-29-43	Al 50-240/2	60	43	IZO-16	246,20	10	50	12,80	 8605031039917
8	50-240	S41-29-47	Al 50-240/2	60	72	-	317,70	-	50	16,38	 8605031039924

Other characteristics

Body material: Aluminum alloy-TIN-COATED
Bolt / Washer: Galvanized steel (other per client request)
Required tools: Wrench of appropriate size
Marking: Manufacturer, cable cross-section, screw tightening torque

